

(Burial Guide) 500 Gallon Underground Installation

Location of A.S.M.E. Cylinders
From NFPA 58, Appendix G

Federal, state, and local ordinances and regulations should be observed at all times.

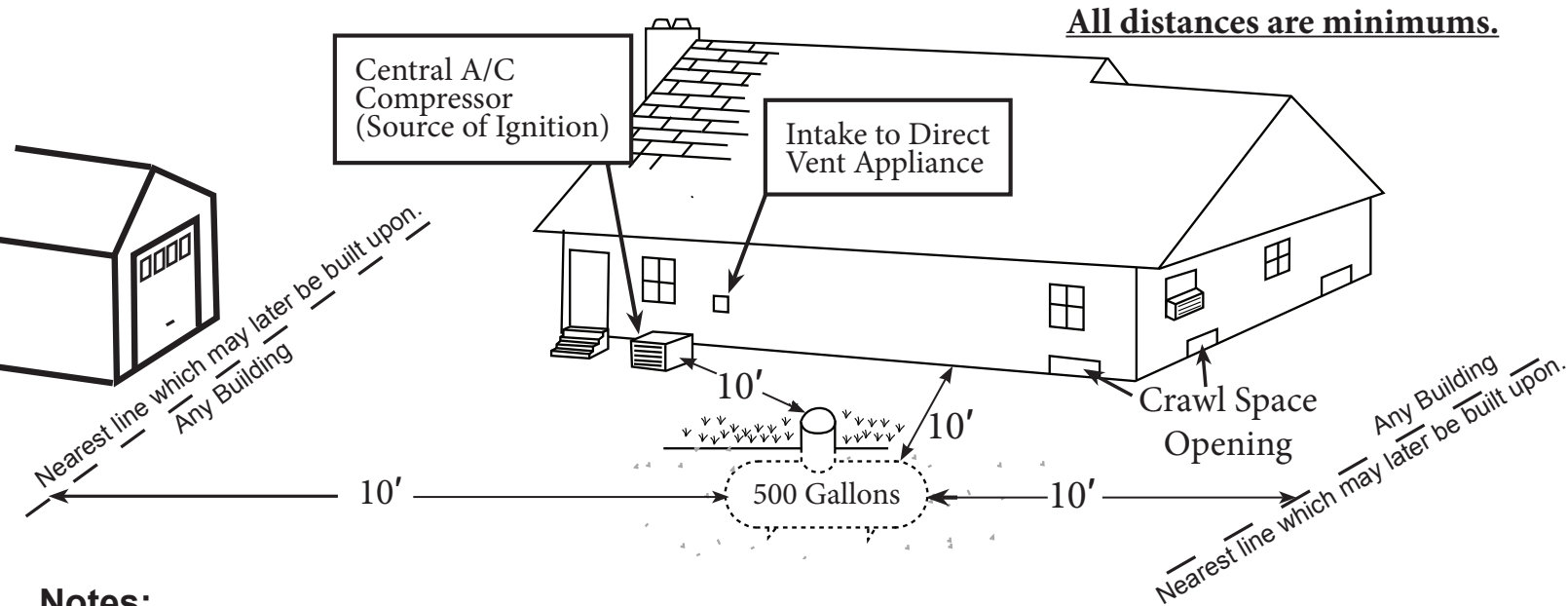

Notes:
Propane tank may not be under or against buildings. Bury at least 6" below grade, 18" if under parking lot, add bollards around valve cover if less than 10' from traffic / roadway. Tank valve cover must be at least 10' from exterior sources of ignition, (air conditioner, transformer or generator) openings into direct-vent gas appliances, or mechanical ventilation air intake, no part of underground tank shall be less than 10' from any building (foundation), well, septic system or adjoining property line which may later be built upon.

Wet area? Tie down to 10" thick concrete pad 3' wider and longer than tank, one #4 rebar / foot.

Approx. 3-6 tons of pipe sand needed to get 6" around complete tank, sand is, (Available at Martin Limestone, 717-354-1073, Honey Brook Quarry, PA).

Important!!

- 1) Dig hole as shown in diagram (reverse side); Evenly place 6" of pipe sand in bottom of hole then set tank in hole; attach (1) 17lb anode per 500 gallon tank; Remove cardboard box and plastic bag from anode and keep in fabric bag; Lay anode on native soil at bottom of hole; connect copper wire (shipped with anode) to tank; (Tan tank) has a bolt with (2) washers and (2) nuts, strip approximately 4" of copper wire and wrap around stud between washers; tighten nut to ensure a good connection.
- 2) Pour 5 gallons of dirty water onto anode to activate it, inadequate moisture will keep anode from protecting tank, place pipe sand around and over tank until you have 6" of pipe sand on top of tank before backfilling with dirt.
- 3) **Important!! Dirt shall not touch tank! Or excessive pitting will occur!** Keep sloped finished grade to direct water away from tank. An initial cathodic test must be done upon final hook-up, and test it annually by a propane service man with a potential meter to make sure anodes are working properly. Potential meter shall read -.85 volts DC or above. If test fails, tank is not protected. Repair connection or add more anodes.
- 4) **Important!!** Place tall flag next to cover; to alert landscapers, lawnmower, dozer operators and to help locate tank in the snow.
- 5) **Important!!** Fill tank promptly! At least to 40% or more. If excessive rain saturates earth the tank can float up.

These instructions are intended only for a basic installation guide. Always refer to federal, state, and local ordinances and regulations or NFPA 58. 10-14

500 Gallon Tank	\$ _____
Regulator & Fittings.....	\$ _____
1/2" Yellow Coated.....	\$ _____
Copper Tubing (50-100-150 ft. Coils)	\$ _____
Total	\$ _____



Phone: 717.354.5691
676 N. Shirk Road — New Holland, PA 17557
Hours: Mon. thru Fri. 7a.m. - 5p.m. Sat. 7-11:30 a.m.

(Burial Guide) 500 Gallon Underground Installation

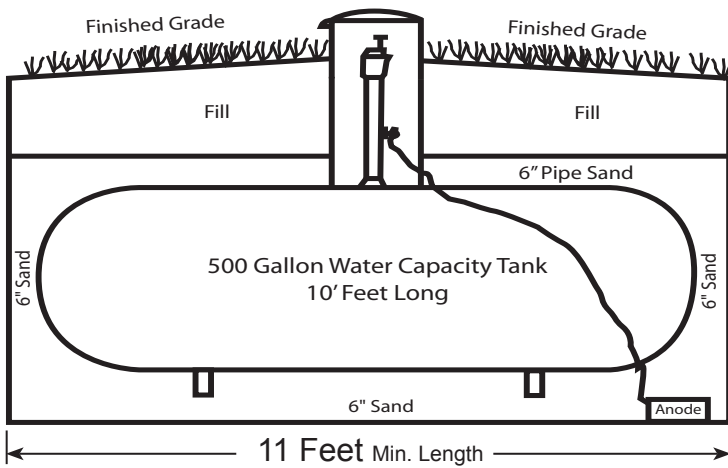

Grade ground downward and away around housing dome. This prevents water from collecting and running into or standing around dome.

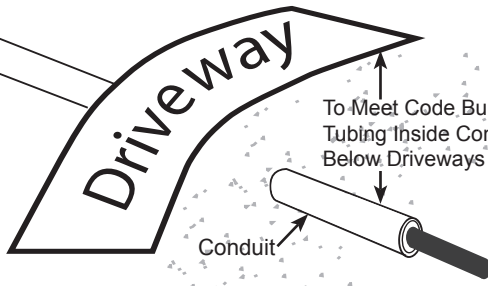
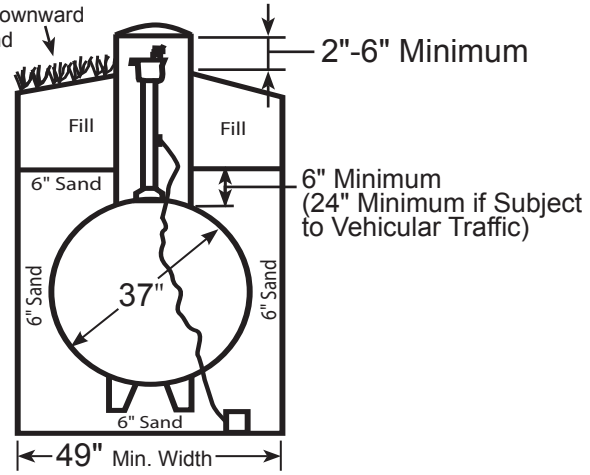

(Red) First Stage Regulator
[Position Regulator as High as Possible Inside Cover]

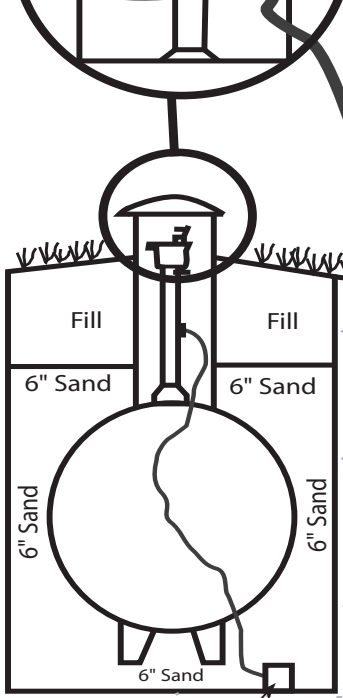
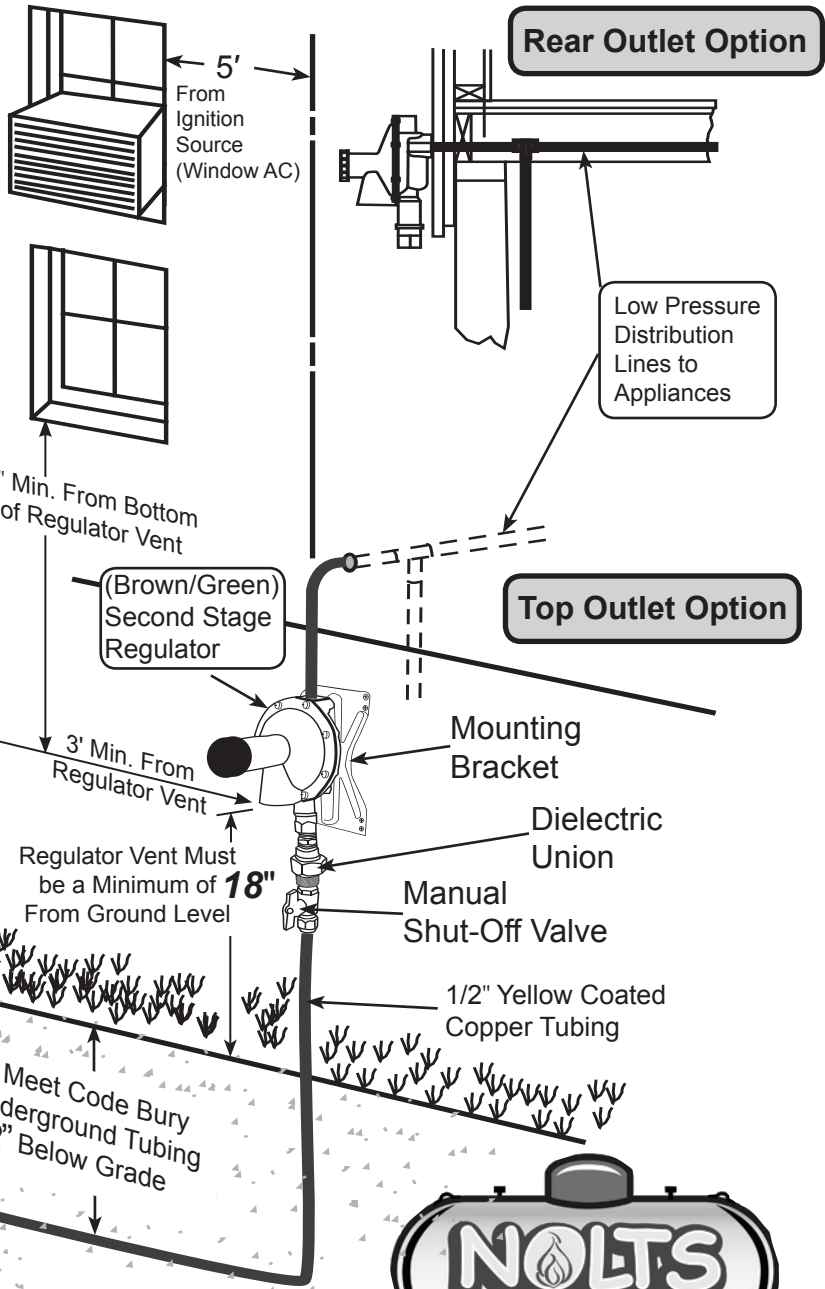
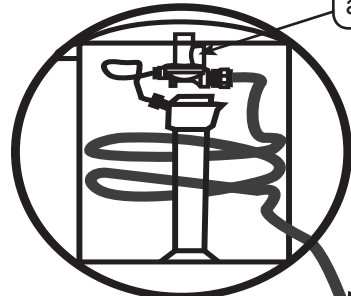

Phone: 717.354.5691
676 N. Shirk Road — New Holland, PA 17557
Hours: Mon. thru Fri. 7a.m. - 5p.m. Sat. 7-11:30 a.m.